

## **BASE** **BAR CLAMP SMALL**

Select appropriate spacer, if required

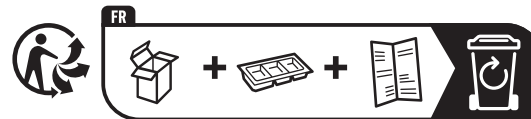
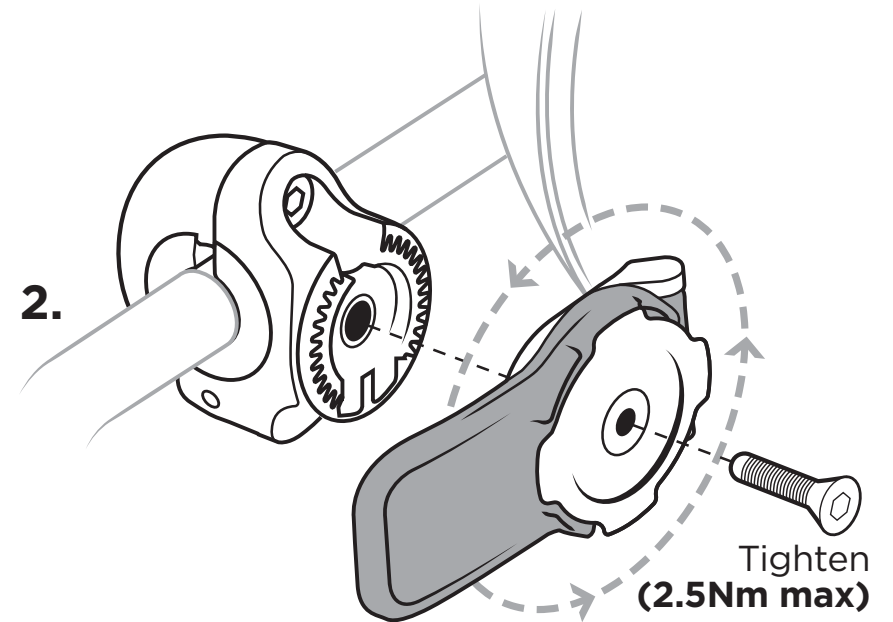
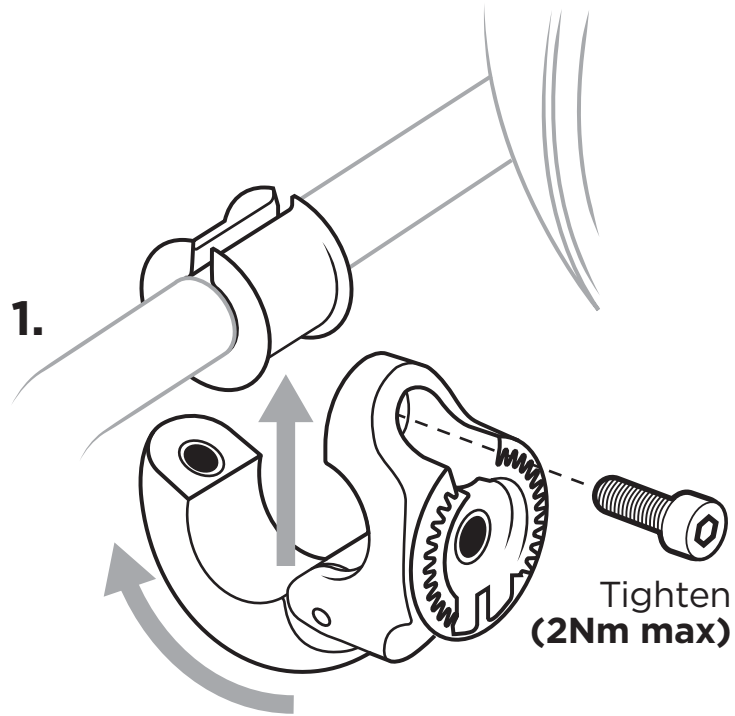
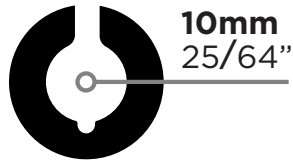
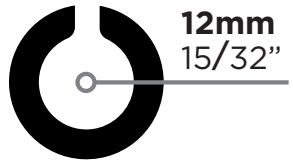
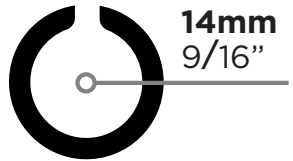
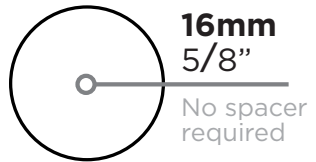

RACCOLTA DIFFERENZIATA.  
VERIFICA LE DISPOSIZIONI DEL TUO COMUNE.  
SVUOTARE L'IMBALLAGGIO.